

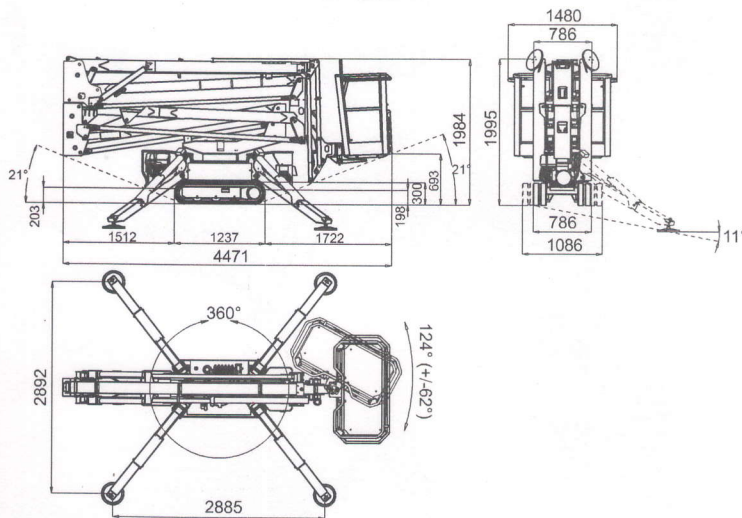

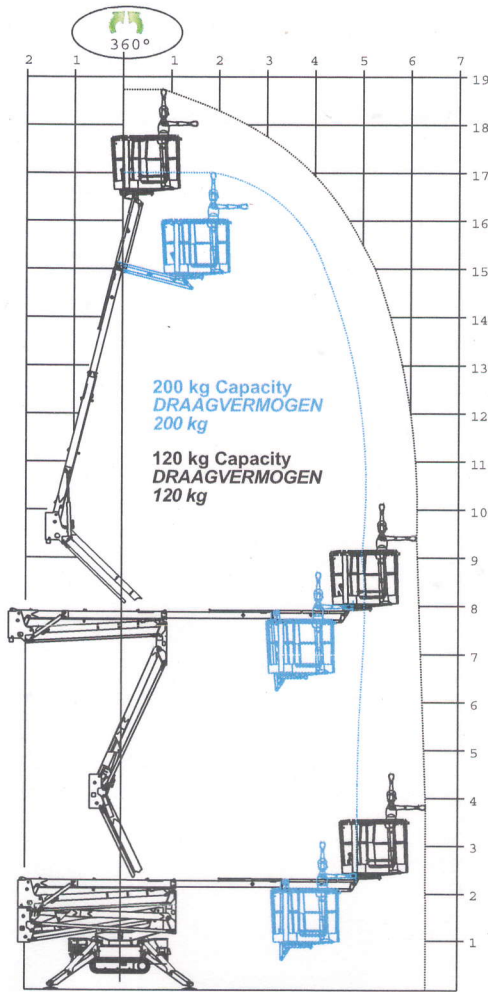

















# SAFETY LIFT LIGHTLIFT 19.65 IIS



-  
-  17,06 m    18,77 m
-  4,80 m    6,40 m
-  4,47 m
-  1,98 m
-  1330x770xh.1100 mm
-  124° (+/-62°)
-  21°/38,4%
-  2098 kg / 4629,71 lb
-  Honda iGX440-15CV-3600rpm  
HATZ 1B40-10CV-3600rpm
-  2,2kw-230V-50Hz-1500rpm  
2,2kw-110V-50Hz-1500rpm
-  Honda: • I 1,7 km/h  
• II 1,7/3,3 km/h (optional-Optioneel)  
Hatz: • I 1,3 km/h  
• II 1,3/2,6 km/h (optional-Optioneel)
-  786/1086 mm
-  2100 daN - 0,62 daN/cm<sup>2</sup>
-  1330 daN - 1,9 daN/cm<sup>2</sup>
-  AUTOMATIC STABILIZING SYSTEM IIS STD.  
AUTOMATISCHE STABILISATIE EN DESTABILISATIE "IIS" IN SERIEPRODUCTIE
-  REMOTE CONTROL DRAADBESTURING
-  GPRS-GPS MODEM STD.  
GPRS-GPS MODEM IN SERIEPRODUCTIE
-  R.A.H.M. REMOTE ASSISTANCE ON HINOWA MACHINES  
R.A.H.M.-REMOTE ASSISTENTIESYSTEEM IN SERIEPRODUCTIE



0%  
Emission



OPTIONAL/OPTIONEEL 90Ah / 48V